

VARIABLE TEMPERATURE DRAWER

SOFVD-90 4GN



Details

- Grade 304 stainless steel interior and exterior
- Digital temperature control and display
- 2 stainless steel drawer that fits 2 x 1/1 GN each drawer
- Auto-defrosting mode
- Heavy duty swivel caster wheels with brake
- Replaceable rubber gasket

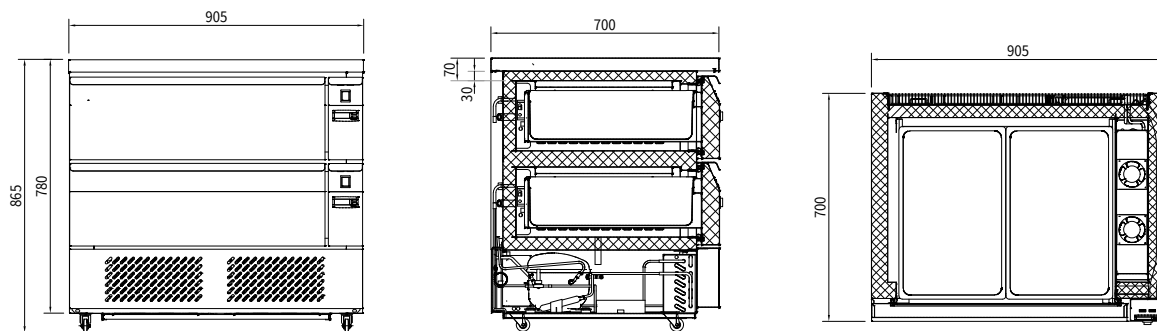

Specifications

Model	Exterior Dimensions WxDxH (mm)	Capacity in Litres	Power (W)	Voltage Supply	Frequency (Hz)	Temperature Range (°C)	Environmental Temperature (°C)	Refrigerant	Mode of Refrigeration
SOFVD-90 4GN	905x700x865	111	460	220V	50/60	+2~+8 / -18~-20	43	R290	Built-in

Sofia Ref. LLC



Sales@sofiaref.com